







## SOLAR SMART BENCH

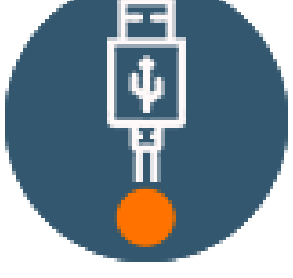

# WYC1916

## DATA SHEET

-  Solar panel
-  Gel battery/LifePO4/Lithium
-  Controller MPPT
-  USB charging ports
-  Wireless charging
-  LED Strip/Spot Light
-  Bluetooth speaker
-  4G International router

# Properties

MODEL NUMBER	WYC1916	Appearance	
DIMENSIONS	203 /68.6 / 309CM		
N.W	180 KG		
G.W	200 KG		
CERTIFICATE	CE / ISO		

**FUNCTION**  
In sunlight mode, the product will charge a built-in battery by a solar panel, and then provide energy for phone chargers, lights and advertising display. Optional smart city with our platform.

Material	201 STAINLESS STEEL + WPC WOOD
Solar panel	MONOCRYSTALLINE SILICON
Solar Power	135W
AC POWER	<b>AC POWER INVERTER: OPTIONAL</b>
CONTROLLER	MPPT CONTROLLER
Battery type	GEL/LIFEPO4/LITHIUM BATTERY
Working temp	-20C-40C/-20C-65C
Battery capacity	12V / 55AH
USB charger	2 PC USB CHARGING PORTS: 5V/9V/12V (2.1A)
Wireless Charger	2 PC - QI STANDARD
Sensors	MOTION SENSOR / <b>OTHER SENSORS ARE OPTIONAL</b>
Wifi router	WI-FI: 4G/INTERNATIONAL ROUTER
Bluetooth speaker	BLUETOOTH SPEAKER 5/12V
LED lighting	STRIP LIGHT: WARM WHITE/WHITE/RGBW
Large LED light box	2 LED LIGHT BOX AND MONOCHROME
NVIDIA Jetson Box	<b>OPTIONAL</b>
Adlis smart platform	<b>OPTIONAL - contact: <a href="mailto:mori@adlissmart.com">mori@adlissmart.com</a> for more information</b>
Display/LED screen	<b>OPTIONAL</b>
10 mm tempered glass	<b>NO</b>
Smart Camera	<b>OPTIONAL</b>
Small LED light box	<b>NO</b>
SOS security	<b>SOS BUTTON: OPTIONAL</b>
Network broadcast	<b>OPTIONAL</b>
Smart voice	<b>OPTIONAL</b>
Bin compressor	<b>NO</b>
Disinfection	<b>NO</b>

**Battery message**  
The controller works well above-40C. while the working efficiency of battery is getting less and less under 0C, when -10C it already doesn't work. Yet after the temperate rises back to over 0C, it will work again. Therefore, in very cold winter the chargers on bench don't work.  
In good sunshine, the battery is fully charged in about 7-8 hours.

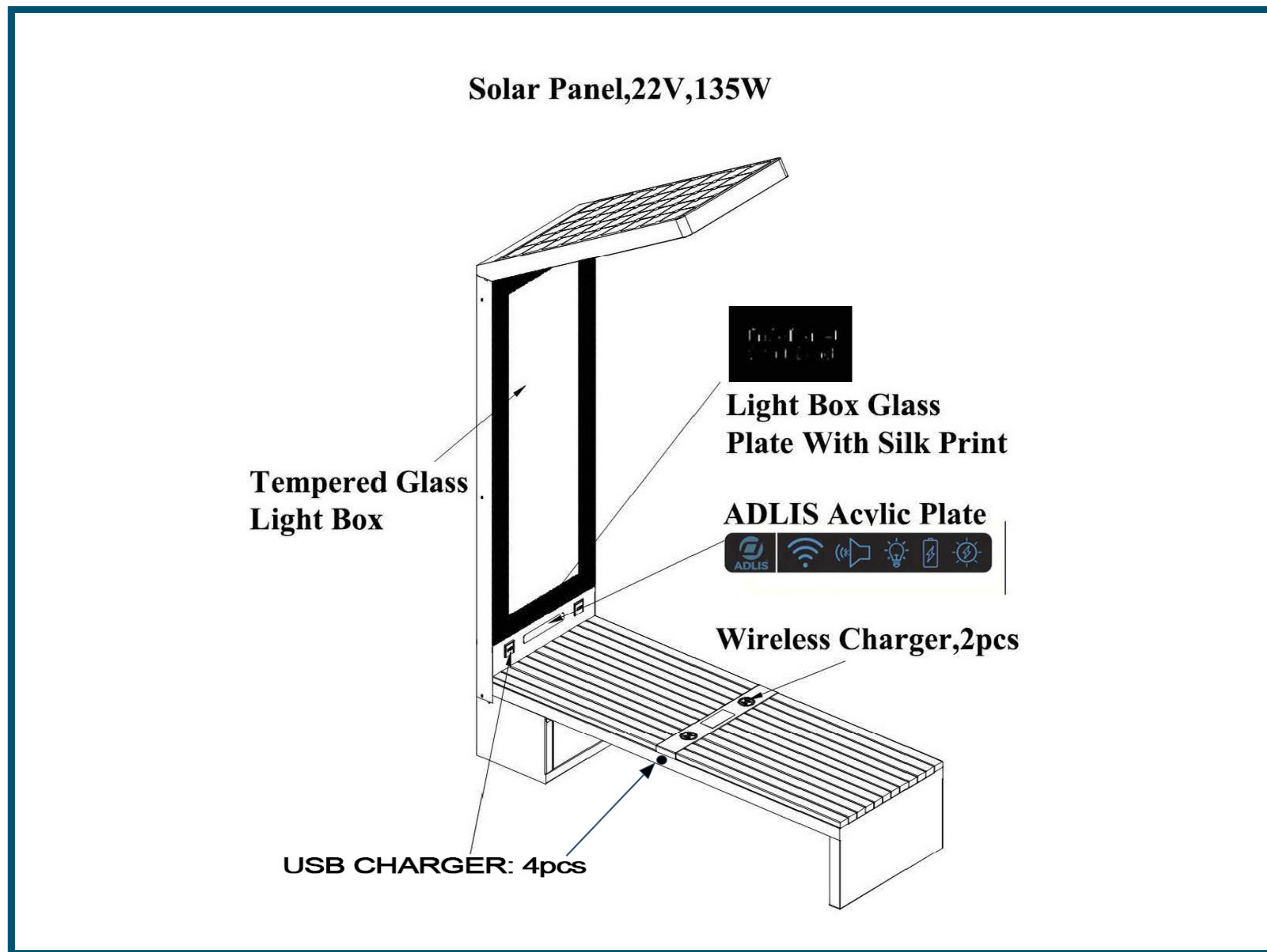
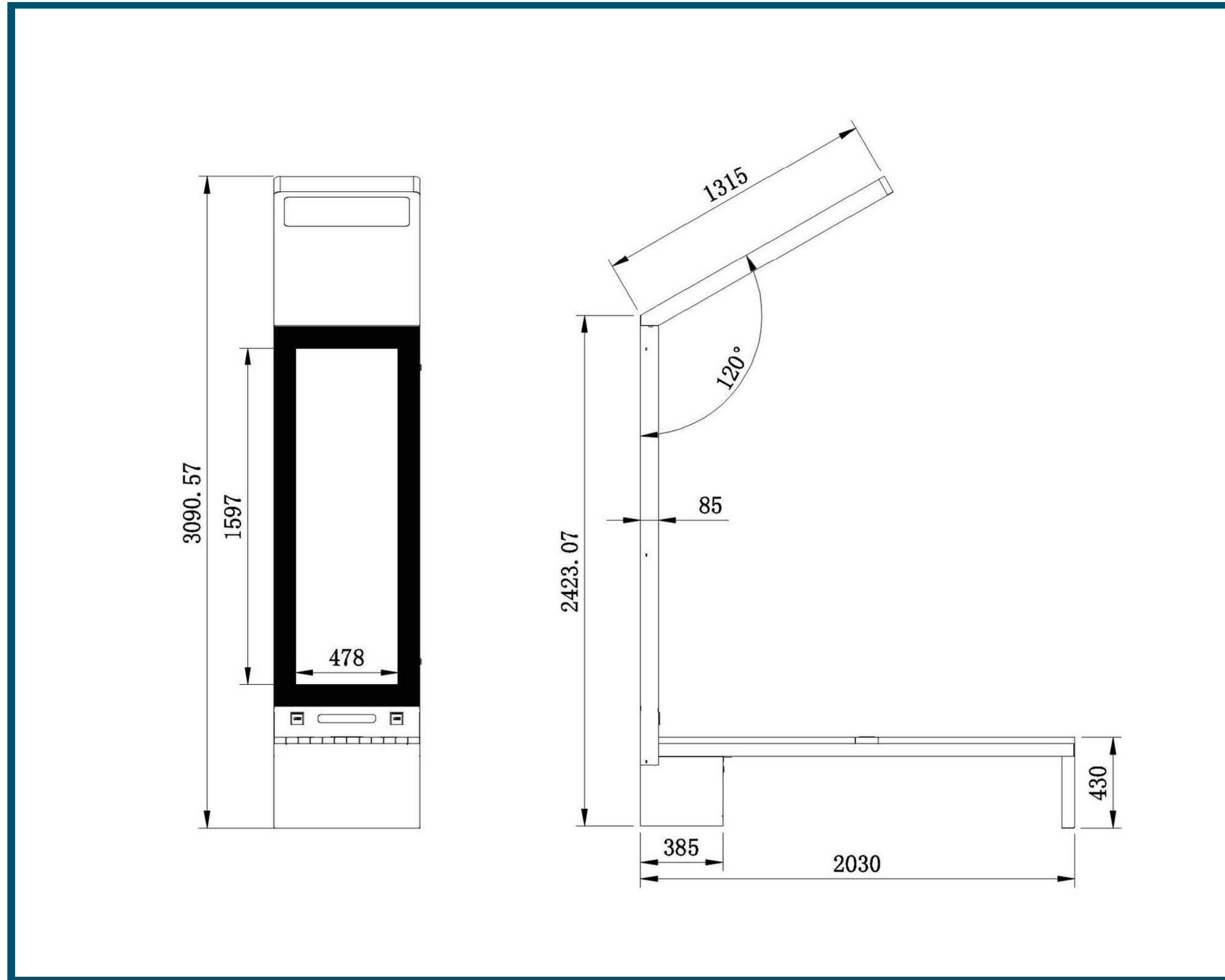

## A. Description and function:

The Adlis Solar Mobile Charging Bus shelter is perfect for short term mobile multi-taskers or a connection space for focused tasks. its charges 2 devices simultaneously.

Works with all Apple, Android and other popular devices.

## B. Intended use:



This product is for external use only. Please place it on a flat floor and away from any shade. If in the shade, the solar panel will not function effectively.

## C. Package Content:

1 unit Adlis Solar Bench Smart

1 pc manual

1 set of expansion screw

## D. Security instructions

## E. Connection and operation:

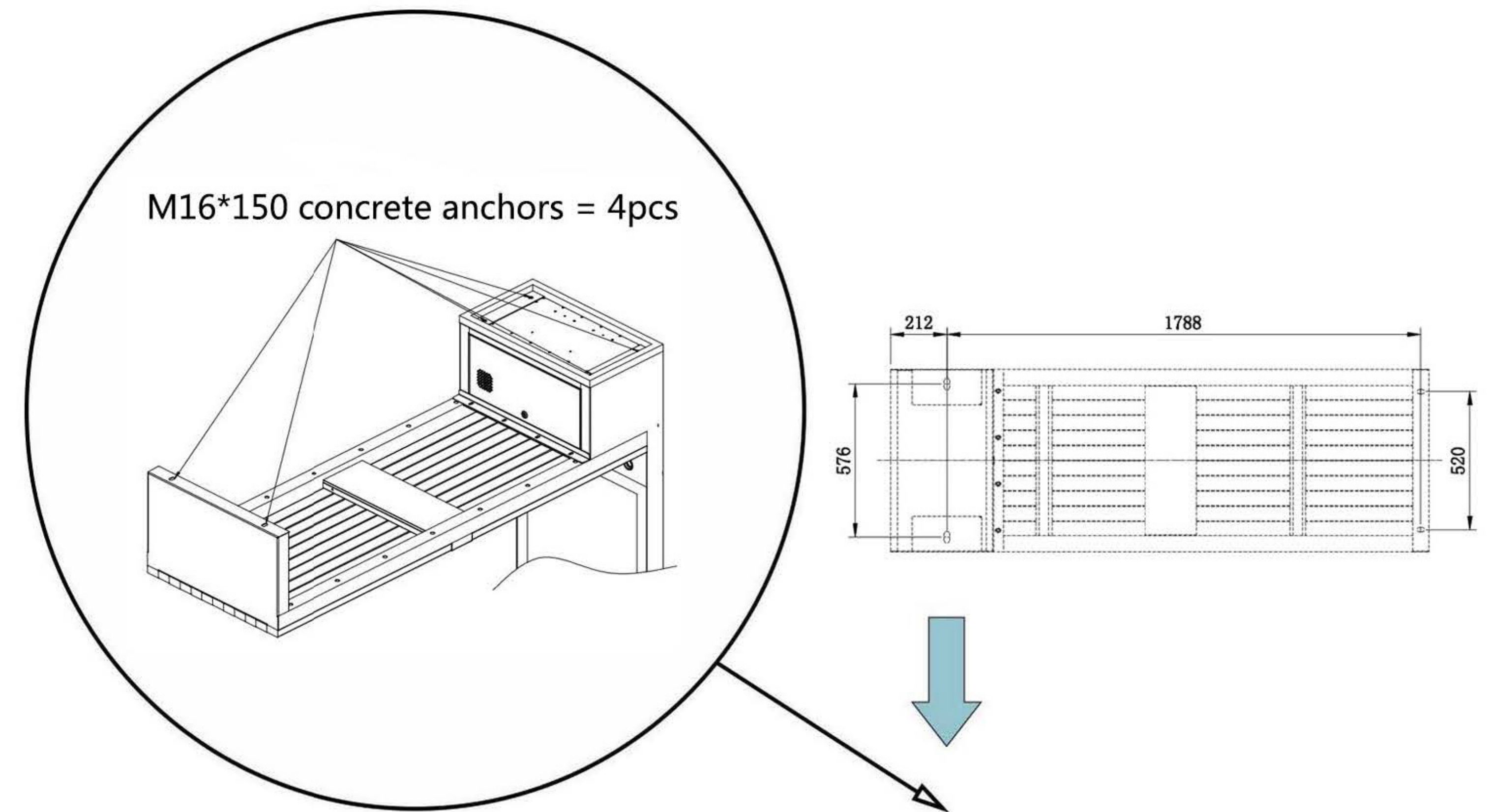

## F. Care, Maintenance, Storage and Transport:



### ATTENTION

We recommended that a qualified person use it to assemble and disassemble the product to avoid any risk of product deterioration.

The product is self-service, meaning users do not need help charging their device

Read carefully and follow the safety instructions for handling, maintenance, storage and transport.

We recommended using the original packaging for transportation to protect the product from dust and moisture.

**WE ARE NOT RESPONSIBLE FOR DAMAGE TO PEOPLE OR PROPERTY CAUSED BY IMPROPER INSTALLATION OR OPERATION THAT IS NOT DESCRIBED IN THIS MANUAL. ANY CHANGE AND/OR MODIFICATION TO THE PRODUCT OR ITS ACCESSORIES IMMEDIATELY CANCELS THE WARRANTY.**



### WARNING!

We recommended that a qualified person use it to assemble and disassemble the product to avoid any risk of product deterioration.

We provide a two-year conditional warranty for this device from the date of purchase

The warranty also does not cover accidental damage or vandalism caused to the products

The warranty also does not cover the charging cables. We have no control over how users treat the cables. Once the product is installed on your premises, replacement cables can be purchased at an additional cost.

**WE ARE NOT RESPONSIBLE FOR DAMAGE TO PEOPLE OR PROPERTY CAUSED BY IMPROPER INSTALLATION OR OPERATION THAT IS NOT DESCRIBED IN THIS MANUAL. ANY CHANGE AND/OR MODIFICATION TO THE PRODUCT OR ITS ACCESSORIES IMMEDIATELY CANCELS THE WARRANTY.**



INSPIRATION  
NEW  
CONCEPT  
NEW



ADLIS  
SMART

We don't make the future, we make the future better.



[www.adlissmart.com](http://www.adlissmart.com)

INSPIRATION  
NEW  
CONCEPT

ADLIS  
SMART



We don't make the future, we make the future better.

[www.adlissmart.com](http://www.adlissmart.com)





**REMARKS: ALL PRODUCTS ARE PACKED IN POLYWOOD BOXES.**

BRANDS AND NUMBERS	PROPERTY DESCRIPTION	UNITS	UNITS/CTN	CTNS	G.W. KGS	N.W. KGS	MEAS (CM)
	<b>WYC1916</b>	<b>1</b>	<b>1</b>	<b>1</b>	<b>255 KG</b>	<b>200 KG</b>	<b>260*62*87</b>
<b>Total</b>		<b>1</b>	<b>1</b>	<b>1</b>	<b>255 KG</b>	<b>200 KG</b>	<b>1.41CBM</b>

**This packing detail is for 1 Pc sample, for bulk order the detailed packing details we be provided before shipment.**

# CONTACT US



**E-MAIL:**

[sales@solarbenchchina.com](mailto:sales@solarbenchchina.com)

**E-MAIL:**

[info@adlissmart.com](mailto:info@adlissmart.com)

**PHONE:**

0086 13823126631

**WEB:**

[www.adlissmart.com](http://www.adlissmart.com)

[www.solarbenchchina.com](http://www.solarbenchchina.com)